

BOLGHERI

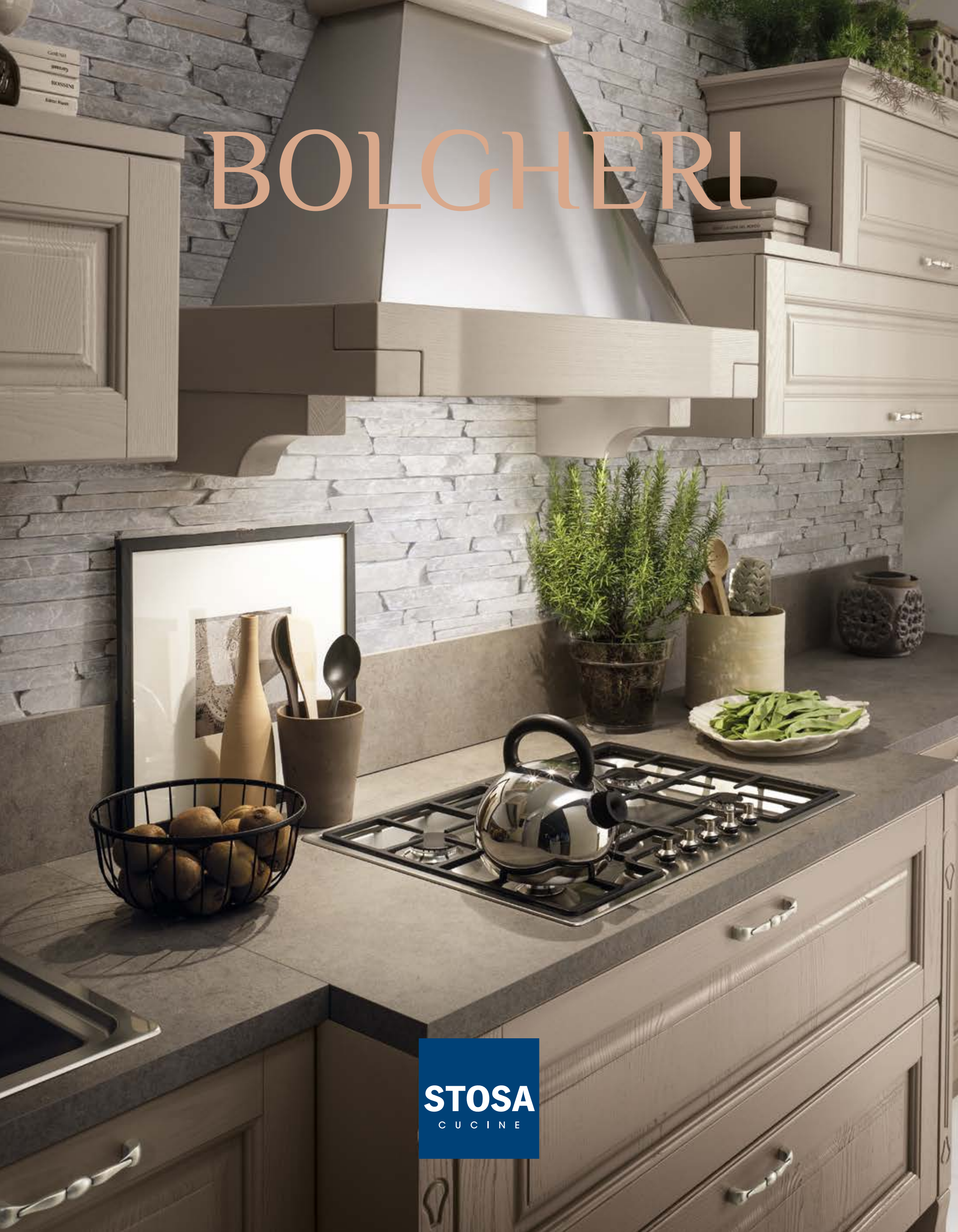

STOSA
CUCINE

STOSA

UNA FAMIGLIA ITALIANA. 50 ANNI DI STORIA E UNA SOLA GRANDE PASSIONE: LA CUCINA.

DA 50 ANNI PRODUCIAMO SOLO CUCINE, CREATE E PRODOTTE PER MIGLIORARE LA VITA DI CHI, OGNI GIORNO, VIVE NELLO SPAZIO PIÙ CONVIVIALE DELLA CASA. PROGETTIAMO E REALIZZIAMO ESCLUSIVAMENTE IN ITALIA PRODOTTI ECCELLENTI NELLA QUALITÀ, REALMENTE SOSTENIBILI PER OGNI FAMIGLIA ITALIANA E PER I GIOVANI. ECCO PERCHÉ UNA CUCINA STOSA NASCE DA VALORI AUTENTICI COME IMPEGNO, ONESTÀ, RISPETTO E ORIGINALITÀ. IN ITALIA E IN OLTRE 40 PAESI NEL MONDO, CON UN MERCATO IN COSTANTE ESPANSIONE. IMPEGNO PER DARE IL MEGLIO DI NOI ATTRAVERSO OGNI SINGOLA CUCINA, DIRETTAMENTE A CASA TUA. ONESTÀ PER TRASFORMARE I NOSTRI PROGETTI IN SPAZI DI VITA DAVVERO SOSTENIBILI. RISPETTO PER LA NATURA CHE CI CIRCONDA E PER TUTTA LA FILIERA PRODUTTIVA. ORIGINALITÀ PER ESSERE SEMPRE PIÙ COMPETITIVI NELL'INNOVAZIONE TECNOLOGICA E FUNZIONALE. È COSÌ CHE OGNI GIORNO COSTRUIAMO LE NOSTRE CUCINE. PENSANDO A TE.

STOSA, AN ITALIAN FAMILY. 50 YEARS OF HISTORY AND ONE GREAT PASSION: KITCHENS.

FOR 50 YEARS WE'VE BEEN PRODUCING ONLY KITCHENS, DESIGNED AND BUILT FOR THOSE WHO ENJOY SPENDING TIME IN THE MOST WELCOMING ROOM IN THE HOME. OUR PRODUCTS, DESIGNED AND MADE ENTIRELY IN ITALY, STAND OUT FOR THEIR QUALITY YET ARE AFFORDABLE FOR ITALIAN FAMILIES AND YOUNG PEOPLE. BECAUSE A STOSA KITCHEN IS BASED ON AUTHENTIC VALUES LIKE COMMITMENT, HONESTY, RESPECT AND ORIGINALITY - IN ITALY AND A 40 OTHER COUNTRIES WORLDWIDE, WITH A CONSTANTLY GROWING MARKET. COMMITMENT TO OFFER OUR BEST IN EVERY SINGLE KITCHEN, DIRECTLY IN YOUR OWN HOME. HONESTY TO TURN OUR DESIGNS INTO TRULY SUSTAINABLE LIVING AREAS. RESPECT FOR THE NATURE SURROUNDING US AND FOR THE WHOLE PRODUCTION CHAIN. ORIGINALITY TO BE MORE AND MORE COMPETITIVE IN REGARDS TECHNOLOGICAL AND PRACTICAL INNOVATION. THAT'S HOW WE BUILD OUR KITCHENS EVERY DAY. THINKING OF YOU.

STOSA, ИТАЛЬЯНСКАЯ СЕМЬЯ. 50 ЛЕТ ИСТОРИИ И ТОЛЬКО ОДНО БОЛЬШОЕ ПРИСТРАСТИЕ – КУХНЯ.

ВОТ УЖЕ 50 ЛЕТ МЫ ПРОИЗВОДИМ ТОЛЬКО КУХНИ, СОЗДАВАЕМЫЕ И ВЫПУСКАЕМЫЕ ДЛЯ УЛУЧШЕНИЯ ЖИЗНИ ТЕХ, КТО КАЖДЫЙ ДЕНЬ ПРОВОДИТ МНОГО ВРЕМЕНИ В САМОМ ПОПУЛЯРНОМ МЕСТЕ ДОМА. МЫ ПРОЕКТИРУЕМ И ПРОИЗВОДИМ ИСКЛЮЧИТЕЛЬНО В ИТАЛИИ ПРЕВОСХОДНЫЕ ПО КАЧЕСТВУ ИЗДЕЛИЯ, ДЕЙСТВИТЕЛЬНО, ПРИЕМЛЕМЫЕ ДЛЯ ЛЮБОЙ СЕМЬИ И ДЛЯ МОЛОДЕЖИ. ВОТ ПОЧЕМУ КУХНЯ STOSA РОЖДАЕТСЯ ОТ НАСТОЯЩИХ ЦЕННОСТЕЙ, ТАКИХ КАК СТАРАТЕЛЬНОСТЬ, ЧЕСТНОСТЬ, БЕРЕЖНОЕ ОТНОШЕНИЕ К ОКРУЖАЮЩЕЙ СРЕДЕ И ОРИГИНАЛЬНОСТЬ. В ИТАЛИИ И В БОЛЕЕ ЧЕМ 40 СТРАНАХ МИРА, С ПОСТОЯННО РАСТУЩИМ РЫНКОМ. СТАРАТЕЛЬНОСТЬ, ЧТОБЫ ДАТЬ ЛУЧШЕЕ, ЧТО МЫ МОЖЕМ ПРЕДЛОЖИТЬ ПОСРЕДСТВОМ КАЖДОЙ КУХНИ НЕПОСРЕДСТВЕННО ВАШЕМУ ДОМУ. ЧЕСТНОСТЬ, ЧТОБЫ ВОПЛОТИТЬ НАШИ ПРОЕКТЫ В ДЕЙСТВИТЕЛЬНО ПРИЕМЛЕМОЕ ЖИЛОЕ ПРОСТРАНСТВО. БЕРЕЖНОЕ ОТНОШЕНИЕ К ОКРУЖАЮЩЕЙ НАС ПРИРОДЕ И КО ВСЕЙ ПРОИЗВОДСТВЕННОЙ ЦЕПОЧКЕ. ОРИГИНАЛЬНОСТЬ, ЧТОБЫ БЫТЬ ВСЕ БОЛЕЕ КОНКУРЕНТОСПОСОБНЫМИ В ИННОВАЦИОННОЙ И ФУНКЦИОНАЛЬНОЙ ТЕХНОЛОГИИ. ВОТ ТАК КАЖДЫЙ ДЕНЬ МЫ И СОЗДАЕМ НАШИ КУХНИ. ДУМАЯ О ВАС.

BOLGHERI

Un nuovo stile di vita tra **Romanticismo** e **Natura**

A new lifestyle between Romanticism and Nature

Indice Index



01 SOYA CUVÉE
PAG 04



02 SOYA
PAG 16



03 CUVÉE
PAG 26



04 BIANCO COTONE
PAG 36



05 BURRO
PAG 46



06 BURRO E ROVERE NATURALE
PAG 58



07 ROVERE NATURALE
PAG 68



08 BURRO E ROVERE NATURALE
PAG 76

BOLGHERI ¹ *Joya* *Cuwèe*

Un progetto classico
per la vita di tutti i giorni
A classic design for everyday living

Una cucina bella da vivere, ricca di accessori e dal design armonioso che recupera la bellezza e la solidità del legno: trova ispirazione nei casolari di campagna ed è perfetta per la vita in città.

A kitchen of beauty to be lived, full of accessories and characterised by a harmonious design that recaptures the beauty and solidity of wood: the inspiration is found in country cottages and is perfect for urban living.



BOLGHERI *Soya*
Cuvée



BOLGHERI *Soya*
Cuvée

BOLGHERI *Soya* *Cuvèe*



Non solo bella, la cucina diventa professionale: con ante vasistas, cassetti, cestoni e ampi piani di lavoro, la funzionalità è di casa.

Not just beautiful, the kitchen becomes professional: with lift-up doors, drawers, baskets and spacious work surfaces, the functionality is at home

**I colori
dell'armonia**
Harmonious colours





BOLGHERI *Soya*
Cuvée

BOLGHERI

*Bianco cotone
e Rovere naturale*

Luminosa e accogliente:
gioca con i colori più delicati della terra
e della natura che catturano la luce
ampliando gli spazi e attualizzano
ogni composizione rendendola
perfettamente abbinabile a contesti
di arredo contemporaneo.

Bright and welcoming:
a play of the most delicate colours of
the earth and nature that catch the light
expanding spaces and that actualize
each composition matching it perfectly
with contexts of contemporary furniture.



BOLGHERI *Soya
Cuvée*



BOLGHERI *Joya* 2

Gli spazi delle emozioni Emotional spaces

Luoghi ben organizzati, con spazi ottimizzati e componenti che allargano la cucina all'ambiente living: per creare situazioni d'arredamento originali e funzionali.

Well organized places, with optimized space and components that expand the kitchen to the living environment: to create situations of original and functional furnishing.



BOLGHERI
Joya
con boiserie in Bianco cotone

Soya BOLGHERI
con boiserie in Bianco cotone



Personalizzare con stile
Personalize with style

Ogni composizione è unica.
Crea il tuo ambiente cucina adattandolo alle tue abitudini:
la penisola snack è anche un piano di lavoro comodo e
spazioso, con boiserie e mensole per esporre e avere
tutto a portata di mano.

Each composition is unique.
Create your kitchen environment, adapting it to your
habits: the snack peninsula is also a comfortable and
spacious worktop with wood panelling and shelves
made to display and have everything at hand.



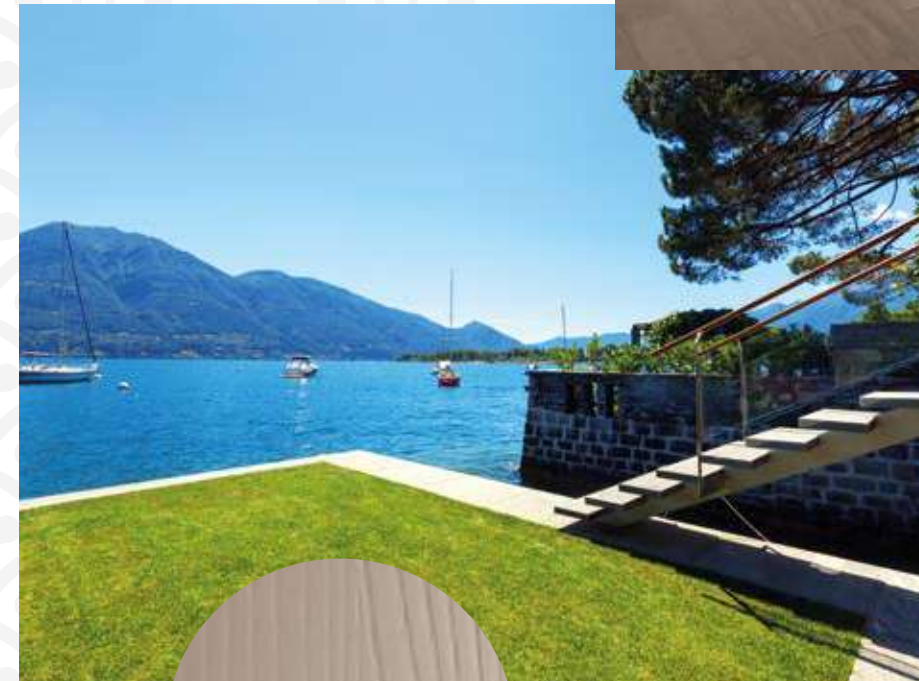

L'arte di saper ricevere

The art of welcoming

La cucina Bolgheri è un inno alla convivialità. Progettata per cuochi in erba soddisfa al meglio le esigenze dei più raffinati gourmet.

The kitchen Bolgheri is an ode to conviviality. Designed for budding chefs, satisfies the needs of the most refined gourmets.

BOLGHERI *Soya*
con boiserie in Bianco cotone



Sapiente gioco di pieni e vuoti: ogni elemento permette di creare un ambiente dinamico, grazie ad ante in vetro e ante piene, mensole e piani di appoggio dalle diverse altezze.

A clever play of solids and voids: each item allows to create a dynamic environment, through glass and solid doors, shelves and worktops of different heights.

BOLGHERI
Soya
con boiserie in Bianco cotone

BOLGHERI 3

Cuvée

Bellezza oltre il tempo
Beauty beyond time

Non sempre pulizia formale fa rima con minimalismo: abbiamo pensato a una cucina elegante e armoniosa, che non dimentica la bellezza delle forme dolci il calore della materia, bella da essere usata, senza temere l'usura del tempo.

Clean lines doesn't always rhymes with minimalism: we thought of a harmonious and stylish kitchen, which does not forget the beauty of the soft shapes and the gentle warmth of the material, beautiful to be used, without fearing the wear of time.



BOLGHERI
Cuvée
con boiserie in Soya



BOLGHERI
Cuvée
con boiserie in Soya



Cucinare
diventa un piacere
Cooking becomes a pleasure

Ogni dettaglio è studiato per rendere il lavoro in cucina un vero piacere: dai piani di lavoro spaziosi ed ergonomici alle armadiature capienti e attrezzate.

Every detail is designed to make work in the kitchen a true pleasure: from spacious and ergonomic worktops to capacious and fully equipped cabinets.





L'estetica ritrovata

Rediscovered aesthetics

Come le cucine di un tempo ha piccoli decori che impreziosiscono le nicchie della penisola, elemento attuale che ottimizza gli spazi nella duplice funzione di piano snack e piano di lavoro.

Like the kitchens of yesteryear it has small decorations that adorn the niches of the peninsula, current element that optimizes spaces in the double snack bar and work surface function.

BOLGHERI
Cuvée
con boiserie in Soya

BOLGHERI
Cuvée
con boiserie in Soya

Le finiture dai toni materici rendono Bolgheri un elemento vivo e naturale, la ricerca estetica è dedicata a chi ama l'originalità dell'eleganza sobria e misurata.

The textural toned finishes make Bolgheri a living and natural element, the aesthetics is dedicated to those who love the originality of sober and measured elegance.



BORGHERI ⁴ *Bianco cotone*

Nei Luoghi della tradizione
In the places of tradition

Un omaggio ai borghi della Toscana: la delicatezza del design, la forza del legno, la cura artigianale, tutto concorre a creare la magia delle cose di un tempo.

A tribute to Tuscan villages: the delicacy of the design, the strength of the wood, the craftsmanship, all contribute to the magic of the things of the past.



BOLGHERI
*Bianco
cotone*

BOLGHERI

Bianco cotone



Interpretazione
di un grande classico
Interpretation
of a great classic



Una nuova interpretazione della cucina classica: grazie alla freschezza dei toni luminosi della finitura Bianco Cotone, Bolgheri attualizza gli elementi stilistici della tradizione.

A new interpretation of the classic kitchen: thanks to the freshness of the bright tones of the Bianco Cotone finish, Bolgheri actualizes the stylistic elements of tradition.





Tradizione e innovazione rendono la cucina perfetta per le esigenze di vita contemporanea: un progetto intelligente che rende più facile e pratico l'utilizzo quotidiano.

Tradition and innovation make the perfect kitchen for the needs of contemporary life: an smart design that makes daily use easy and practical.

BOLGHERI
*Bianco
cotone*



BOLGHERI
*Bianco
cotone*



Tutto è in ordine e tutto è funzionale:
gli elementi sono studiati per il massimo
contenimento, cestoni e armadiature
sono attrezzati al meglio per avere tutto in ordine.

All in order and everything functional: the elements
are designed for maximum storage, deep drawers
and cabinets are perfectly equipped to have
everything in order.

BOLGHERI 5

Burro

La leggerezza di una
passeggiata in riva al mare
The levity of a walk by the sea

La scelta stilistica della finitura Burro decapè ricorda la Provenza e la leggerezza di una vacanza in Costa Azzurra: un'ispirazione naturale per un progetto solido studiato in ogni dettaglio.

The stylistic choice of the Burro decapè finish recalls the Provence and the levity of a holiday on the French Riviera: natural inspiration for a solid design studied in every detail.



BOLCHERI
Burro

BOLGHERI

Burro



Particolari
di stile
Style details



Ogni elemento è perfettamente integrato nell'insieme della composizione, sviluppando un piacevole gioco di volumi: come la cappa angolare che si completa di un'originale teca porta spezie integrata all'area cottura.

Each element is seamlessly integrated throughout the composition, developing a pleasant dimensional play: such as the angular hood which includes an original spice rack integrated with the hob area.





Burro
BOLGHERI



La cura nelle cose
che amiamo

The care in the
things we love

Ogni progetto è studiato con amore e ha dettagli unici: i pensili disposti a geometria sfalsata o la colonna terminale con nicchie a giorno creano un ambiente confortevole, fatto per accogliere.

Each project is designed with love and unique details: the staggered wall units or the end tall unit with open recesses create a comfortable and accommodating environment.



La convivialità è di casa, quando lo spazio è utilizzato al meglio e ogni elemento concorre alla funzionalità.

Conviviality is at home when space is used to its best and each element contributes to the functionality.



BOLGHERI *Burro*



BOLGHERI
Burro



BOLGHERI

6

*Butiro
e Rovere naturale*

Un equilibrio di sensazioni materiche A balance of material sensations

L'ambiente cucina diventa il cuore della casa con soluzioni arredative che coinvolgono in maniera armoniosa il living o che si adattano all'open space, con finiture che giocano con il calore del legno e la luminosità del bianco.

The kitchen becomes the heart of the home with furnishing solutions that harmoniously engage the living area or that adapt to open spaces, with finishes that play with the warmth of wood and the brightness of white.



BOLGHERI
*Burro
e Rovere naturale*

Burro BOLGHERI
e Rovere naturale



Personalizza
con la materia
Personalize with
substance



I toni leggeri della finitura Burro decapè incontrano lo stile sicuro della finitura Rovere naturale in un armonioso gioco di equilibri.

The light tones of the Burro decapè finish meet the confident style of the natural Oak finish in a harmonious balancing act.





Burro BOLGHERI
e Rovere naturale



L'area operativa e il living dialogano grazie a moduli studiati per essere la naturale estensione della cucina.

The working and living area interact thanks to modules designed to be a natural extension of the kitchen.



A tropical garden scene featuring a stone pool with clear blue water, a wooden cart with large wheels, and lush greenery including banana trees and a rice field in the background. The sky is bright blue with scattered white clouds.

BOLGHERI 7

Rovere naturale

Alla ricerca del tempo perduto
In search of days gone by

Ci sono luoghi e profumi che riportano alla memoria i valori di una tradizione i cui particolari sono studiati con grande passione e ci fanno scoprire tutta l'autenticità del tempo passato.

There are places and fragrances that conjure up the values of tradition the peculiarities of which are studied with great passion and allow us to discover the authenticity of the past



BOLGHERI
Rovere naturale



BOLGHERI

Rovere naturale



Progettata per
vivere meglio
Designed for
better living



Ogni modulo è attrezzato e studiato per avere la massima capienza; la maniglia o il pomolo sapientemente lavorati con motivo a intarsio impreziosiscono la composizione.

Each module is equipped and designed for maximum capacity; the handle or knob, skilfully worked with inlaid motif, adorn the composition.





BOLGHERI *Rovere naturale*

La collezione Bolgheri eccelle nell'intento di interpretare la cucina classica con nuovi elementi: i moduli living si integrano alla composizione per un risultato armonioso e funzionale.

The Bolgheri collection excels in the intent to interpret the classic kitchen with new elements: the living area modules integrate with the composition for a harmonious and functional result.





L'estetica della tradizione toscana rivive nella composizione dove la credenza è protagonista e la penisola snack ha una forma originale nella variante curva.

The aesthetics of Tuscan tradition regains strength in the composition where the dresser is the protagonist and the snack peninsula acquires an original form in the curved version.



BOLGHERI 8

Rovere naturale e Burro

PROPOSTE COMPOSITIVE / COMPOSITION IDEAS

Composizione / Composition 01



- finitura Cuvèe e Soya
- Maniglia Argento Antico
- Top Laminato Pietra Vecchia

- Cuvèe and Soya finish
- Antique Silver handle
- Pietra Vecchia laminate top

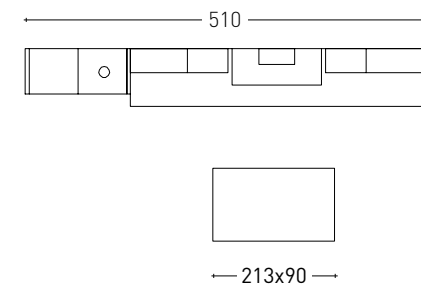

Page: 4

Composizione / Composition 02



- finitura Soya
- Maniglia Argento Antico
- Top Laminato Pietra Vecchia

- Soya finish
- Antique Silver handle
- Pietra Vecchia laminate top

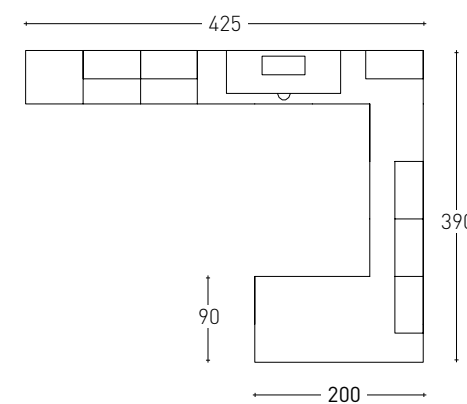

Page: 16

Composizione / Composition 03



- finitura Cuvèe
- Maniglia Argento Antico
- Top Laminato Luserna Bianco

- Cuvèe finish
- Antique Silver handle
- Luserna Bianco laminate top

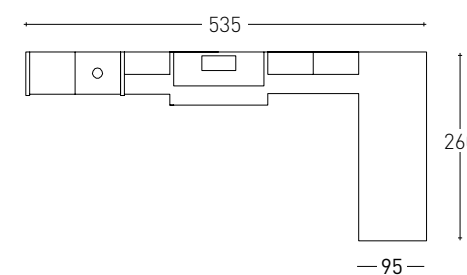

Page: 26

Composizione / Composition 04



- Finitura Bianco Cotone
- Maniglia MX0A
- Top marmo Grabla Levigato sp.3.
- Sedia legno S14
- Tavolo allungabile con 1 prolunga

- White Cotton finish
- Handle MX0A
- Grabla smoothed marble top 3 cm
- Wooden chair S14
- Extensible table with 1 extension

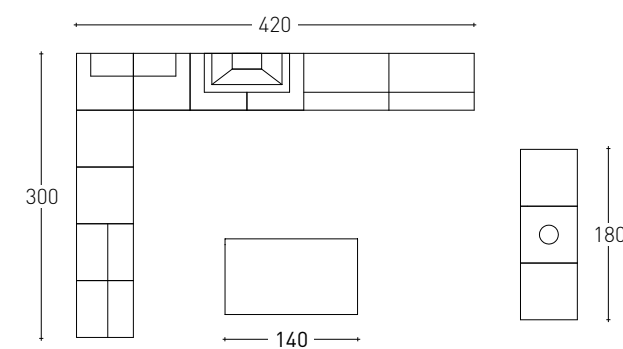

Page: 36

PROPOSTE COMPOSITIVE / COMPOSITION IDEAS

Composizione / Composition 05



- Finitura Burro
- Maniglia MX0
- Top laminato Luserna Bianco sp.4.
- Sedia legno S14
- Tavolo rotondo allungabile

- Butter finish
- Handle MX0
- Luserna White laminate top 4 cm
- Wooden chair S14
- Extensible round table

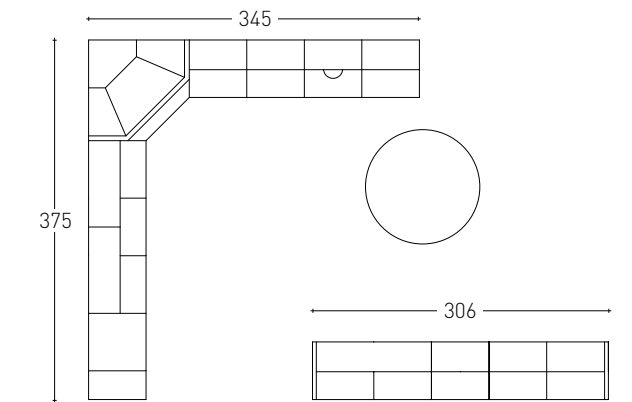

Page: 46

Composizione / Composition 06



- Finitura Rovere natura e Burro
- Maniglia MX0A, Pomolo PX0B
- Top laminato Corten Sabbia sp.4.
- Sedia legno S14
- Tavolo allungabile con 2 prolunghe

- Natural Oak and Butter finish
- Handle MX0A, Knob PX0B
- Corten Sand laminate top 4 cm
- Wooden chair S14
- Extensible table with 2 extensions

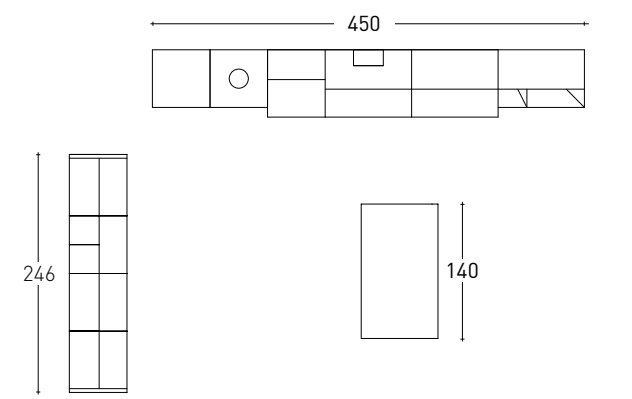

Page: 58

Composizione / Composition 07



- Finitura Rovere natura
- Maniglia MX0A, Pomolo PX0B
- Top laminato Corten Sabbia sp.4.
- Sedia legno S14
- Tavolo allungabile con 2 prolunghe

- Natural Oak
- Handle MX0A, Knob PX0B
- Corten Sand laminate top 4 cm
- Wooden chair S14
- Extensible table with 2 extensions

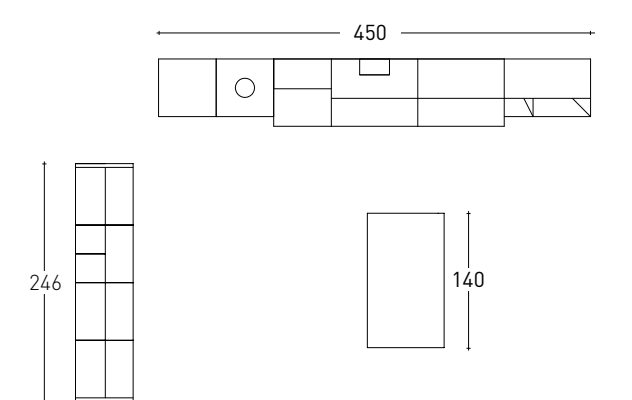

Page: 68

Composizione / Composition 08



- Finitura Rovere natura e Burro
- Maniglia MX0, Pomolo PX0B
- Top Okite
- Piazza del Campo 3 cm.
- Sgabello legno SGA10

- Natural Oak and Butter finish
- Handle MX0, Knob PX0B
- Piazza del campo Okite top 3 cm.
- Wooden stool SGA10

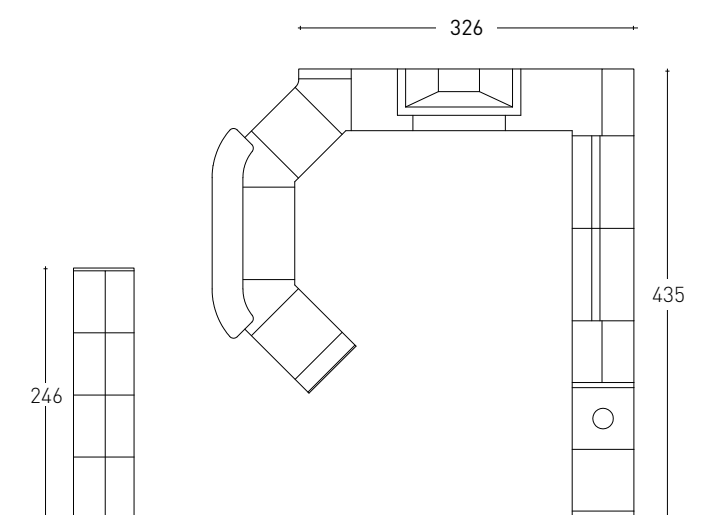

Page: 76

TIPOLOGIA STRUTTURA / STRUCTURES TYPE

STRUTTURA CHAMPAGNE / CHAMPAGNE STRUCTURE



Fianchi strutturali laminati o impiallacciati sp. 18 mm finiti nei bordi frontali, superiori, inferiori più lato esterno a vista, con interno sempre champagne come scocca (di serie con colori: Rovere Naturale, Burro).
Laminated or veneered 18 mm thick structural side panels finished on the front, upper and lower edges plus on the outside face, with champagne on the inside as the carcass (colours as standard: natural oak, Burro).

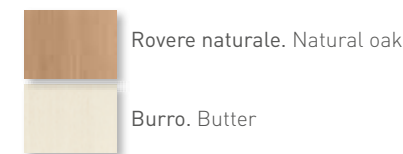

Champagne. Champagne.



Fianchi strutturali disponibili solo impiallacciati sp. 18 mm finiti nei bordi frontali, superiori, inferiori più lato esterno a vista, con interno sempre champagne come scocca. Veneered only 18 mm thick structural side panels finished on the front, upper and lower edges plus on the outside face, with champagne on the inside as the carcass.

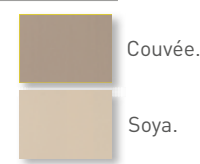

STRUTTURA BIANCA INTERNO CHAMPAGNE / WHITE STRUCTURE, CHAMPAGNE INTERIOR



Fianchi strutturali laminati o impiallacciati sp. 18 mm finiti nei bordi frontali, superiori, inferiori più lato esterno a vista, con interno sempre champagne come scocca (di serie con colore Bianco Cotone).
Laminated or veneered 18 mm thick structural side panels finished on the front, upper and lower edges plus on the outside face, with champagne on the inside as the carcass (Bianco Cotone colour as standard).



Bianco. White.

STRUTTURA ANTRACITE INTERNO CHAMPAGNE / ANTRACITE STRUCTURE, CHAMPAGNE INTERIOR



Fianchi strutturali laminati o impiallacciati sp. 18 mm finiti nei bordi frontali, superiori, inferiori più lato esterno a vista, con interno sempre champagne come scocca (a richiesta).
Laminated or veneered 18 mm thick structural side panels finished on the front, upper and lower edges plus on the outside face, with champagne on the inside as the carcass (on request).

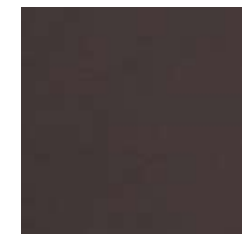

Antracite. Antracite.

MANIGLIE / HANDLES

MANIGLIA DI SERIE / STANDARD HANDLE



cod. MX0A
←→ 128 mm

Finitura argento anticato
Antique silver finish



cod. PX0

Pomolo finitura argento anticato
Knobs antique silver finish

MANIGLIE OPZIONALI / OPTIONAL HANDLES



cod. MX0
←→ 128 mm

Finitura argento anticato
Antique silver finish



cod. MX0B
←→ 128 mm

finitura argento lucido
Glossy silver finish



cod. PX0B

Pomolo finitura argento lucido
Knobs glossy silver finish

TIPOLOGIA ANTE / TYPE OF DOORS

TELAIO E BUGNA IN LEGNO ROVERE / WOODEN FRAME AND OAK PANEL



Anta piena Rovere Naturale
Oak Natural full door



Telaio inglese Rovere Naturale con vetro Bronzo semitrasparente
English frame Oak Natural with glass semitransparent Bronze



Cesto pieno Rovere Naturale
Oak Natural full deeo-pan drawer



Cassetto Rovere Naturale
Oak Natural drawer



Anta piena Burro
Burro full door



Telaio inglese Burro con vetro Bronzo semitrasparente
English frame Burro with glass semitransparent Silver



Cesto pieno Burro
Burro full deeo-pan drawer



Cassetto Burro
Burro drawer



Anta piena Bianco Cotone
Bianco Cotone full door



Telaio inglese Bianco Cotone con vetro Bronzo semitrasparente
English frame Bianco Cotone with glass semitransparent Silver



Cesto pieno Bianco Cotone
Bianco Cotone full deeo-pan drawer



Cassetto Bianco Cotone
Bianco Cotone drawer



Anta piena Soya
Soya full door



Telaio inglese Soya con vetro Bronzo semitrasparente
English frame Soya with glass semitransparent Silver



Cesto pieno Soya
Soya full deeo-pan drawer



Cassetto Soya
Soya drawer



Anta piena Cuvée
Cuvée full door



Telaio inglese Cuvée con vetro Bronzo semitrasparente
English frame Cuvée with glass semitransparent Silver



Cesto pieno Cuvée
Cuvée full deeo-pan drawer



Cassetto Cuvée
Cuvée drawer

TAVOLI & SEDIE / TABLES AND CHAIRS

Tavoli e sedie sono disponibili in tutte le finiture del modello (compresi i nuovi colori Soya e Cuvée)
 Tables and chairs are available in the same finishes as the model (including the new colours Soya and Cuvée)

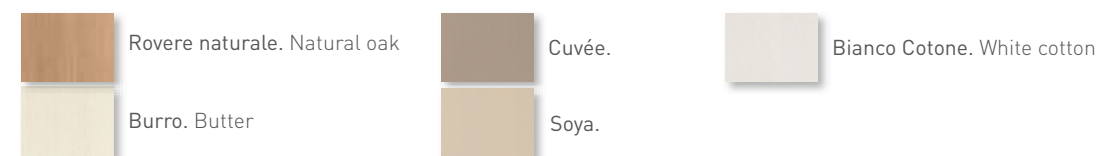

Tavolo allungabile con piano impiallacciato L.125/150x80 H.77,5 con 1 prolunga
 Extensible table with veneered top W.125/150x80 H.77,5 with 1 extension



Tavolo allungabile con piano impiallacciato L.140 H.80,5 con 2 prolunghe
 Extensible table with veneered top W.140 H.80,5 with 2 extensions



Tavolo allungabile rotondo con piano impiallacciato Ø120 H.77,5
 Round extensible table with veneered top Ø120 H.77,5

TAVOLI & SEDIE / TABLES AND CHAIRS

Tavoli e sedie sono disponibili in tutte le finiture del modello (compresi i nuovi colori Soya e Cuvée)
 Tables and chairs are available in the same finishes as the model (including the new colours Soya and Cuvée)

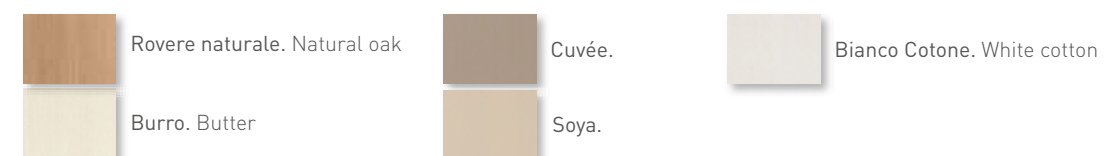

Sedia legno S14 con seduta imbottita in microfibra.
 Wooden chair S14 with upholstery seat.

Sgabello legno SGA10 con seduta imbottita in microfibra.
 Wooden stool SGA10 with upholstery seat.

Sedia in legno F15 disponibile in tutti i colori del modello.
 F15 wooden chair available in all model colours.



Tavolo in legno CROSS allungabile 160x95 con 3 prolunghe da 60 cm.
 CROSS wooden extendible table 160x95 with 3 extensions measuring 60 cm.

T&T COMUNICAZIONE
Art direction and Graphic concept
Copying
Scenic design and art-buyering
Photorealistic 3D
Post-production

Selecolor Firenze
Colour separation

Sincromia
Print

Ristampa Settembre 2015





Stosa S.p.A.

STAB., SEDE AMM.VA E RECAPITO POSTALE:
S.S. Cassia, Km. 149,5
53040 Radicofani (SI) Italy

GPS:
N 42° 53' 50,6"
E 11° 45' 53,5"

INFO:
tel. +39 0578 5711 r.a.
fax +39 0578 50088

INFO LINE:
840 000 691

