

ALIANTE



STOSA
CUCINE

STOSA

- UNA FAMIGLIA ITALIANA - 50 ANNI DI STORIA E UNA SOLA GRANDE PASSIONE LA CUCINA

Da 50 anni produciamo solo cucine, create e prodotte per migliorare la vita di chi, ogni giorno, vive nello spazio più conviviale della casa. Progettiamo e realizziamo esclusivamente in Italia prodotti eccellenti nella qualità, realmente sostenibili per ogni famiglia italiana e per i giovani. Ecco perché una cucina Stosa nasce da valori autentici come impegno, onestà, rispetto e originalità. In Italia e in oltre 40 Paesi nel mondo, con un mercato in costante espansione. Impegno per dare il meglio di noi attraverso ogni singola cucina, direttamente a casa tua. Onestà per trasformare i nostri progetti in spazi di vita davvero sostenibili. Rispetto per la natura che ci circonda e per tutta la filiera produttiva. Originalità per essere sempre più competitivi nell'innovazione tecnologica e funzionale. È così che ogni giorno costruiamo le nostre cucine. Pensando a te.

STOSA, AN ITALIAN FAMILY. 50 YEARS OF HISTORY
AND ONE GREAT PASSION: KITCHENS.

For 50 years we've been producing only kitchens, designed and built for those who enjoy spending time in the most welcoming room in the home. Our products, designed and made entirely in Italy, stand out for their quality yet are affordable for Italian families and young people. Because a Stosa kitchen is based on authentic values like commitment, honesty, respect and originality in Italy and a further 40 countries worldwide, with a constantly growing market. Commitment to offer our best in every single kitchen, directly in your own home. Honesty to turn our designs into truly sustainable living areas. Respect for the nature surrounding us and for the whole production chain. Originality to be more and more competitive with regards technological and practical innovation. That's how we build our kitchens every day. Thinking of you.



ALIANTE
INTERPRETA
UNO DEI MATERIALI
PIÙ PURI: IL VETRO.
UNA CUCINA
CHE PUÒ ESSERE
INTEGRATA CON
ANTE E ELEMENTI
ECLETTICI
PER SOLUZIONI
INEDITE.

Aliant interprets one of the
purest materials: glass.
A kitchen that can be integrated
with doors and eclectic
elements for novel solutions.

1 ^{comp.}	ALIANTE page 04
2 ^{comp.}	ALIANTE+ CITY page 14
3 ^{comp.}	ALIANTE+ MAYA page 22
4 ^{comp.}	ALIANTE+ REPLAY page 26
5 ^{comp.}	ALIANTE+ ALEVE page 32
6 ^{comp.}	ALIANTE+ ALEVE page 36



CUCINA ALIANT:
LA PUREZZA
DELLE ANTE IN VETRO,
SUPERFICI CHE
SI DIFFONDONO
NELLO SPAZIO.

Aliant kitchen: the purity of glass doors, surfaces that disperse in space.

ALIANT



1^{comp.}
ALIA NT

ALIA NT
UN ARMONIOSO
GIOCO DI RIFLESSI,
UNA GRANDE
LEGGEREZZA
VISIVA, UN SOLO
MATERIALE
PROTAGONISTA:
IL VETRO.
LA CUCINA IDEALE CHE
SODDISFA I GUSTI
PIÙ RAFFINATI.

A harmonious play of light, great visual delicacy, one main material: glass.
The ideal kitchen that satisfies the most refined tastes.

Composizione Aliant 01 _ Basi in vetro lucido Frost, pensile in vetro lucido Frost e vetro opaco grigio Daitona con elemento in lamiera Peltro. Gola scavata e zoccolo finitura Titanio. Top e alzatina in finitura Fenix grigio Efeso. Colonna in vetro lucido grigio Daitona con nicchia in lamiera finitura Peltro. Composition Aliant 01 _ Base units in Frost polished glass, wall unit in Frost polished glass and Grigio Daitona opaque glass with Peltro sheet element. Titanio finish for hollow groove and plinth. Fenix Grigio Efeso finish for top and upstand. Tall unit in Grigio Daitona polished glass with Peltro finish sheet recess.

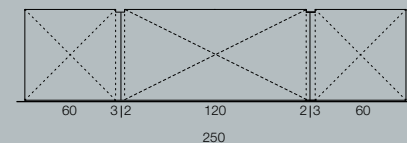
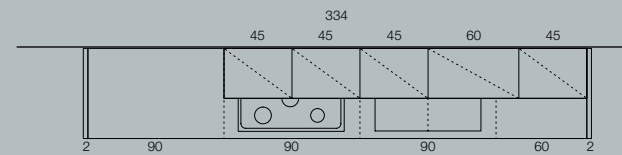



CUCINE BELLE DENTRO E FUORI.

Carter in alluminio finitura Champagne
per ripiani interni al mobile.

Kitchens beautiful both inside and out.
Aluminium casing with champagne finish
for shelves inside the unit.

Attrezzature

EQUIPMENT



Cestone raccolta differenziata con filtro antiodore.
Separate waste collection deep drawer with odour filter.



Cassetti con nuova attrezzatura TAVINEA, con l'assetto obliquo si ottimizza lo spazio.
Drawers with new TAVINEA equipment, optimizes space with the oblique set-up.



Cestone attrezzato con nuova attrezzatura TAVINEA.
Basket with new TAVINEA equipment.

NUOVI MODI DI ORGANIZZARE LO SPAZIO ORDINE GARANTITO CON LA NUOVA LINEA 'TAVINEA'.

Tavinea è un nuovo sistema organizzativo-innovativo all'interno di cassetti e cestoni per gli utensili della cucina.
Cassetti con portaposate dalla moderne linee oblique, utilissimi per ordinare anche i mestoli ed i coltelli più ingombranti.
Una grande ricerca formale anche all'interno dei cestoni con eleganza e ordine, un mix di materiali durevoli come metallo e legno.

New ways to organize space organization guaranteed with the new 'Tavinea' line.
Tavinea is an innovative new organizational system in drawers and baskets for kitchen utensils.
Drawers with cutlery trays characterized by modern oblique lines, ideal for ordering bulkier ladles and knives.
a formal research within the baskets with elegance and order, a mix of durable materials such as metal and wood.

Effetti di Luce



LUCI DETROIT: NUOVE LINEE LUMINOSE LA RICERCA DEL DETTAGLIO.

L'illuminazione all'interno dei cassetti, una sottile fonte di luce per un effetto gradevole e di grande utilità,
DETROIT è la barra luminosa a LED con sensore elettronico che permette l'accensione e lo spegnimento automatico della lampada alla chiusura del cassetto.

Detroit light: new lighting lines he pursuit of detail.
The lighting inside the drawers, a fine light source for a pleasing effect and of great usefulness.
DETROIT is the LED light bar with electronic sensor that automatically switches the lamp on and off again when the drawer is closed.





ALIAN+ CITY LA LUCE AL PUNTO GIUSTO.

STOSA CUCINE è sempre alla ricerca di nuove soluzioni tecnologicamente avanzate. L'interno della colonna è valorizzato dal faretto a Led EMOTION dotato di telecomando che permette di cambiare il colore della luce dall'effetto caldo a freddo. I ripiani STRIKE sono in vetro con telaio in alluminio finitura Champagne abbinati alla scocca interna. Il dettaglio - interno ed esterno - nella cucina diventa una nota distintiva sinonimo di qualità.

Just the right light. STOSA CUCINE is always looking for new technological solutions. The interior of the tall unit is enhanced by the EMOTION Led spotlight with remote control that lets you change the colour effect of the light from warm to cold. The STRIKE shelves are made of glass with Champagne finish aluminum frame combined to the inner carcass. The - internal and external - detail in the kitchen becomes a distinctive note synonymous with quality.

Composizione 02 Aliant + City _ Basi in finitura Rovere Jeans con piano e schienale in laminato colore Bianco Neve. Pensile in finitura Rovere Jeans e vetro lucido Pomice, vano a giorno in lamiera laccata opaco Bianco. Colonna midi e colonna frigo in vetro lucido Pomice. Gola scavata e zoccolo finitura Titanio. Composition 02 Aliant + City _ Base units in Rovere Jeans finish with Bianco Neve finish laminate top and back panel. Wall unit in Rovere Jeans finish and Pomice polished glass, open compartment in Bianco matt lacquered metal sheet. Midi tall unit and fridge tall unit in Pomice polished glass. Titanio finish for hollow groove and plinth.

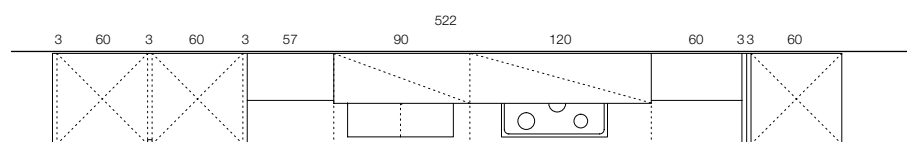

Rovere Jeans Vetro lucido Pomice Laccato Opaco Bianco Titanio



Attrezzature

EQUIPMENT



Cestone estraibile per raccolta differenziata.
Pull-out drawer for separate waste collection.



Cassetto con nuova attrezzatura TAVINEA portaposate obliquo.
Drawers with the new TAVINEA oblique cutlery tray.



Cassettone con nuova attrezzatura TAVINEA.
Deep-pan drawers with the new TAVINEA.

DENTRO AL CASSETTO, MOLTEPLICI POSSIBILITÀ.

Tavinea: nuove attrezzature e accessori per allestire all'interno cassetti e cestoni, spazi confortevoli e ben suddivisi per facilitare le operazioni in cucina.

Various possibilities, Within the drawer.
Tavinea, new equipment and accessories to furnish the inside of drawers and baskets, comfortable and well divided spaces to ease kitchen operations.
Separate waste collection systems like the new base unit with pull-out waste bin.



ALIANT+MAYA
MOLTEPLICI
FINITURE,
MATERIALI
D'EFFETTO
E NOTE DI
COLORE DECISE.

Multiple finishes, impressive materials and decisive hints of colour.





Composizione 03 Aliant + Maya _ Basi in Noce Platin e maniglia Onda in finitura Peltro, pensili in vetro opaco Bianco Ice e opaco Grigio Piacenza con vano a giorno di tipo Z laccato opaco Verde Oliva. Colonna in vetro opaco Bianco con anta e nicchia laccate opache Verde Oliva. Penisola centrale con piano in finitura Fenix color Grigio Londra con telaio Frame laccato Bianco opaco ed elementi Liberty in Fenix Grigio Londra con lamiera laccato opaco Bianco. Zoccolo color Verde Oliva. Composition 03 Aliant + Maya _ Base units in Noce Platin and Onda handle in Peltro finish, wall units in opaque Bianco Ice and opaque Grigio Piacenza glass with Verde Oliva matt lacquered Z type open compartment. Tall unit in opaque Bianco glass with Verde Oliva matt lacquered door and recess. Central peninsula with Grigio Londra colour Fenix finish top with Bianco matt lacquered Frame and Liberty elements in Fenix Grigio Londra with Bianco matt lacquered metal sheet. Verde Oliva colour plinth.

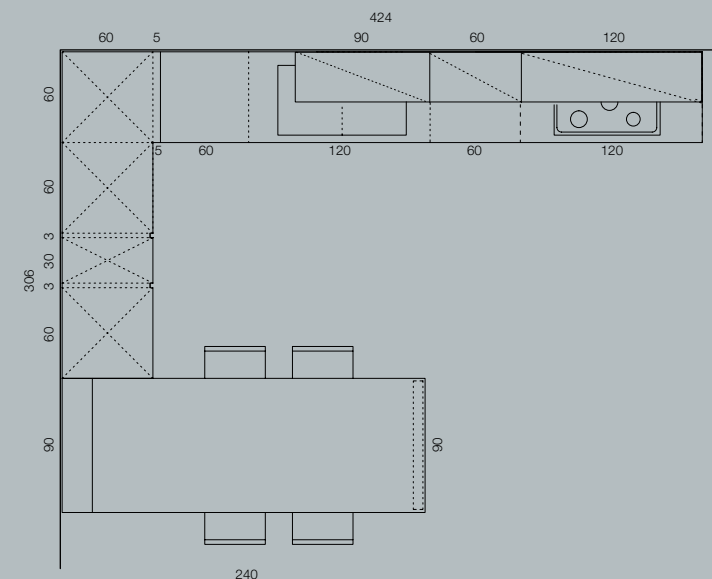

4

comp.
ALIAN+
REPLAY





ALIAN+REPLAY
LIMPIDA ELEGANZA
TRA ESSENZA E VETRO.

Clear elegance between wood and glass.



ALIAN+REPLAY CREATIVA COMBINAZIONE DI MATERIALI E MOVIMENTATE GEOMETRIE.

Creative combination of materials and enlivened shapes.

Composizione 04 Aliant + Replay _ Basi in finitura Pino Grigio con cassetto in vetro lucido Grigio Piacenza. Top e alzatina in laminato Caribe bianco. **Pensili** in vetro lucido Grigio Piacenza e vano a giorno tipo Z in laccato opaco Corda. **Colonne** in vetro lucido Grigio Piacenza e vano a giorno in laccato opaco Corda. **Gole e zoccoli** in finitura Titanio. **Composizione 04 Aliant + Replay** _ Base units in Pino Grigio finish with drawer in Grigio Piacenza polished glass. Top and upstand in Caribe bianco laminate. **Wall units** in Grigio Piacenza polished glass and Corda lacquered matt Z type open compartment. **Tall units** in Grigio Piacenza polished glass and Corda lacquered matt Z type open compartment. Titanio finish for grooves and plinths.

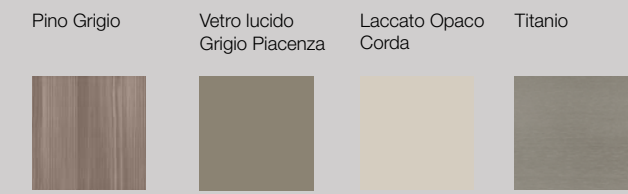
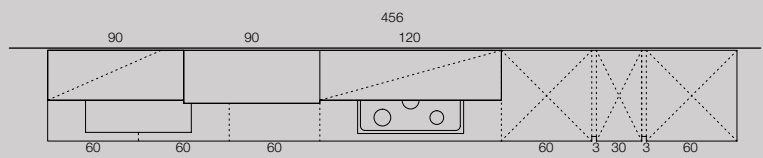





Composizione 05 Aliant + Alevé _ Basi in finitura Materico Calce. **Top, alzatina e fianco** in Fenix grigio Londra. **Pensili** in vetro lucido Grigio Piacenza e vani a giorno laccato opaco Rosso. **Colonne** in vetro grigio Piacenza lucido e vani a giorno laccato opaco Rosso. **Gola piatta e zoccolo** colore Titanio. **Composition 05 Aliant + Alevé** _ Base units in Materico Calce finish. **Top, upstand and side** in Fenix grigio Londra. **Wall units** in Grigio Piacenza polished glass and Rosso lacquered matt open compartment. **Tall units** in Grigio Piacenza polished glass and Rosso lacquered matt open compartment. Titanio colour for flat groove and plinth.

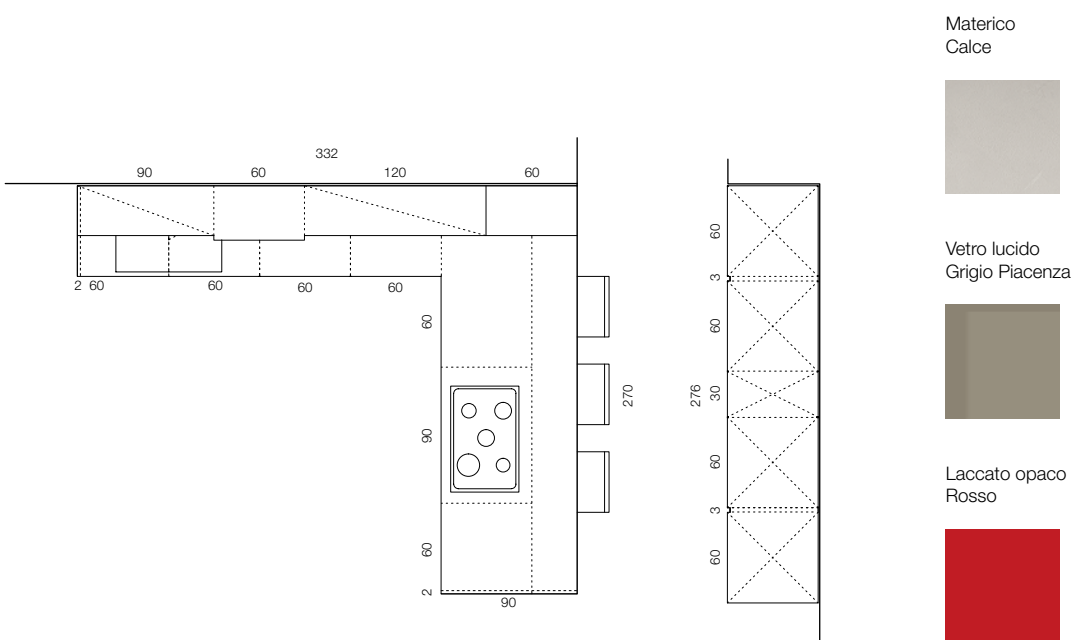

ALIAN+ALEVÉ
IL PIACERE
TATTILE
DELLA
MATERIA.

The tactile pleasure of the material.





ALIAN+ALEVÉ

Composizione 06 Aliant + Alevé _Basi in laccato diretto Bianco Ice opaco e cassetti in vetro lucido Bianco Ice. **Top e alzatina** in laminato rovere Texas. **Pensili** con ante in materico Cemento e vetro lucido Bianco Ice. **Vano a giorno** in lamiera laccata opaco Piombo. **Colonne** con ante in materico Cemento e vetro lucido Bianco Ice. **Gole e Zoccolo** in laccato opaco bianco. Composition 06 Aliant + Alevé _ Base units in directly varnished matt Bianco Ice and Bianco Ice polished glass drawers. **Top and upstand** in Rovere Texas laminate. **Wall units** with Materico Cemento doors and Bianco Ice polished glass. **Open compartment** in Piombo matt lacquered metal sheet. **Tall units** with Materico Cemento doors and Bianco Ice polished glass. Bianco matt lacquered groove and plinth.

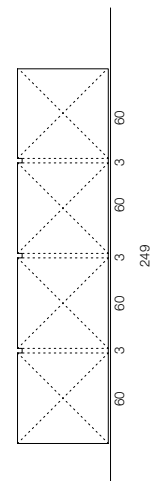
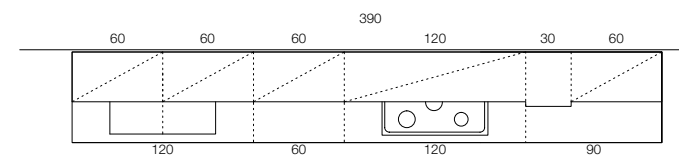
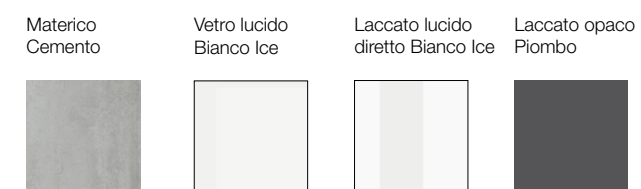

1 comp. ALIANT pag. 4



Composizione Aliant 01 _ Basi in vetro lucido Frost, pensile in vetro lucido Frost e vetro opaco grigio Daitona con elemento in lamiera Peltro. **Gola scavata e zoccolo** finitura Titanio. **Top e alzatina** in finitura Fenix grigio Efeso. **Colonna** in vetro lucido grigio Daitona con nicchia in lamiera finitura Peltro. **Composition Aliant 01** _ Base units in Frost polished glass, wall unit in Frost polished glass and Grigio Daitona opaque glass with Peltro sheet element. Titanio finish for **hollow groove and plinth**. Fenix Grigio Efeso finish for **top and upstand**. **Tall unit** in Grigio Daitona polished glass with Peltro finish sheet recess.

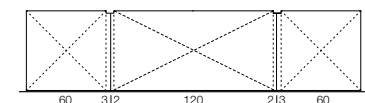
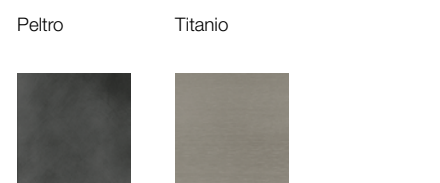
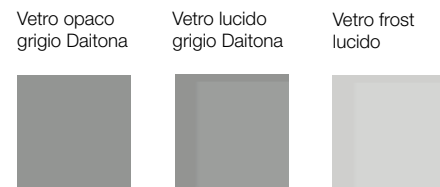
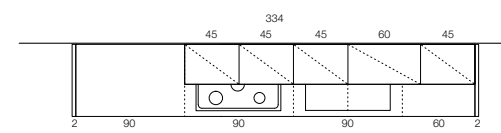

4 comp. ALIANT+ REPLAY pag. 26



Composizione 04 Aliant + Replay _ Basi in finitura Pino Grigio con cassetto in vetro lucido Grigio Piacenza. Top e alzatina in laminato Caribe bianco. **Pensili** in vetro lucido Grigio Piacenza e vano a giorno in laccato opaco Corda. **Colonne** in vetro lucido Grigio Piacenza e vano a giorno in laccato opaco Corda. **Gole e zoccoli** in finitura Titanio. **Composition 04 Aliant + Replay** _ Base units in Pino Grigio finish with drawer in Grigio Piacenza polished glass. Top and upstand in Caribe bianco laminate. **Wall units** in Grigio Piacenza polished glass and Corda lacquered matt Z type open compartment. **Tall units** in Grigio Piacenza polished glass and Corda lacquered matt open compartment. Titanio finish for **grooves and plinths**.

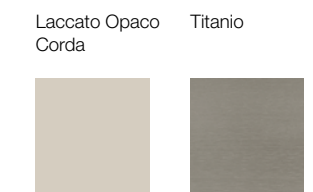
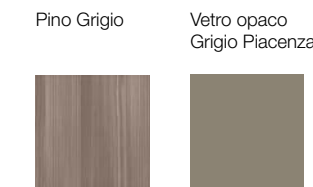
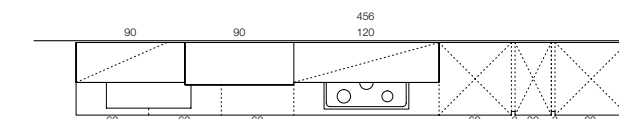

2 comp. ALIANT+ CITY pag. 14



Composizione 02 Aliant + City _ Basi in finitura Rovere Jeans con piano e schienale in laminato colore Bianco Neve. **Pensile** in finitura Rovere Jeans e vetro lucido Pomice, vano a giorno in lamiera laccata opaco Bianco. **Colonna midi e colonna frigo** in vetro lucido Pomice. **Gola scavata e zoccolo** finitura Titanio. **Composition 02 Aliant + City** _ Base units in Rovere Jeans finish with Bianco Neve finish laminate top and back panel. **Wall unit** in Rovere Jeans finish and Pomice polished glass, open compartment in Bianco matt lacquered metal sheet. **Midi tall unit and fridge tall unit** in Pomice polished glass. Titanio finish for **hollow groove and plinth**.

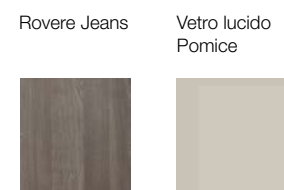
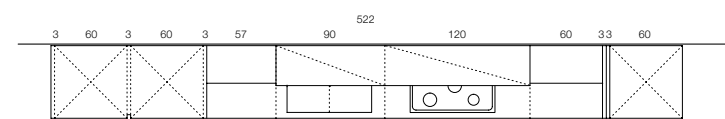

5 comp. ALIANT+ ALEVÉ pag. 32



Composizione 05 Aliant + Alevé _ Basi in finitura Materico Calce. **Top, alzatina e fianco** in Fenix grigio Londra. **Pensili** in vetro lucido Grigio Piacenza e vani a giorno laccato opaco Rosso. **Colonne** in vetro grigio Piacenza lucido e vani a giorno laccato opaco Rosso. **Gola piatta e zoccolo** colore Titanio. **Composition 05 Aliant + Alevé** _ Base units in Materico Calce finish. **Top, upstand and side** in Fenix grigio Londra. **Wall units** in Grigio Piacenza polished glass and Rosso lacquered matt open compartment. **Tall units** in Grigio Piacenza polished glass and Rosso lacquered matt open compartment. Titanio colour for **flat groove and plinth**.

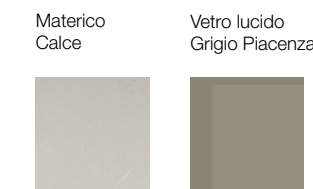
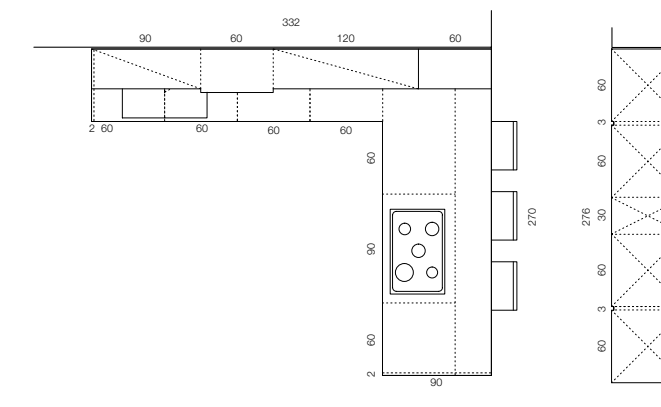

3 comp. ALIANT+ MAYA pag. 22



Composizione 03 Aliant + Maya _ Basi in Noce Platin e maniglia Onda in finitura Peltro, **pensili** in vetro opaco Bianco Ice e opaco Grigio Piacenza con vano a giorno di tipo Z laccato opaco Verde Oliva. **Colonna** in vetro opaco Bianco con anta e nicchia laccate opache Verde Oliva. **Penisola centrale** con piano in finitura Fenix color Grigio Londra con telaio Frame laccato Bianco opaco ed elementi Liberty in Fenix Grigio Londra con lamiera laccato opaco Bianco. **Zoccolo** color Verde Oliva. **Composition 03 Aliant + Maya** _ Base units in Noce Platin and Onda handle in Peltro finish, **wall units** in opaque Bianco Ice and opaque Grigio Piacenza glass with Verde Oliva matt lacquered Z type open compartment. **Tall unit** in opaque Bianco glass with Verde Oliva matt lacquered door and recess. **Central peninsula** with Grigio Londra colour Fenix finish top with Bianco matt lacquered Frame and Liberty elements in Fenix Grigio Londra with Bianco matt lacquered metal sheet. Verde Oliva colour **plinth**.

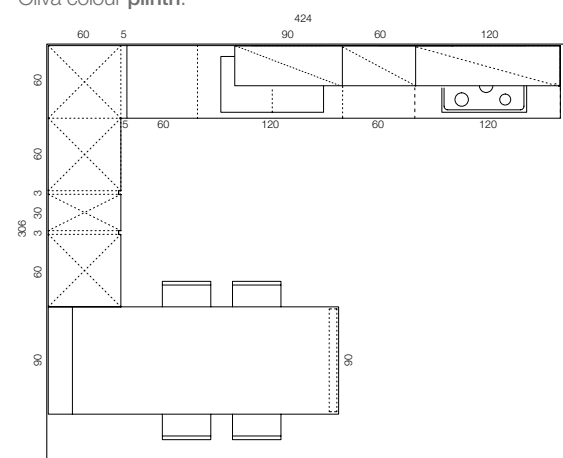

6 comp. ALIANT+ ALEVÉ pag. 36



Composizione 06 Aliant + Alevé _ Basi in laccato diretto Bianco Ice opaco e cassette in vetro lucido Bianco Ice. **Top e alzatina** in laminato rovere Texas. **Pensili** con ante in materico Cemento e vetro lucido Bianco Ice. **Vano a giorno** in lamiera laccata opaco Piombo. **Colonne** con ante in materico Cemento e vetro lucido Bianco Ice. **Gole e Zoccolo** in laccato opaco bianco. **Composition 06 Aliant + Alevé** _ Base units in directly varnished matt Bianco Ice and Bianco Ice polished glass drawers. **Top and upstand** in Rovere Texas laminate. **Wall units** with Materico Cemento doors and Bianco Ice polished glass. **Open compartment** in Piombo matt lacquered metal sheet. **Tall units** with Materico Cemento doors and Bianco Ice polished glass. Bianco matt lacquered **groove and plinth**.

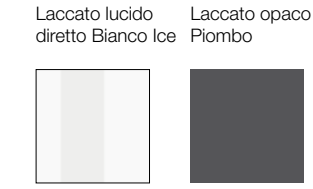
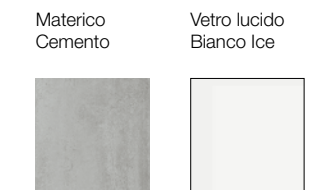
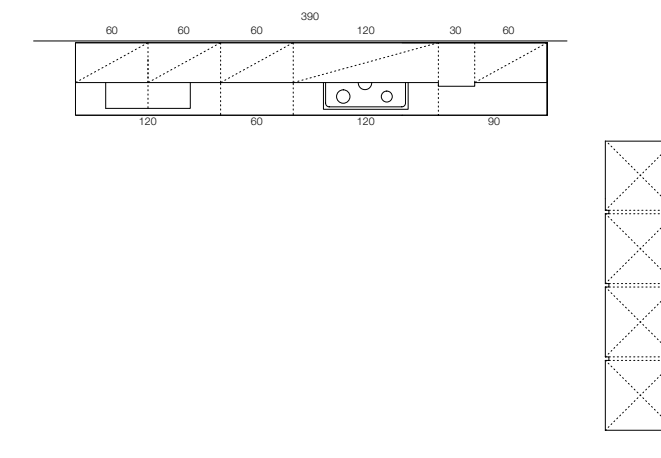

ANTA ALIANT

DOOR



La sottile superficie del vetro appoggia all'interno di un telaio alluminio finitura Titanio, così le ante, una volta chiuse, creano un effetto omogeneo ed elegante.

La maniglia è integrata nel telaio alluminio e reinventa il concetto di gola. Per la cucina Aliant una selezione di vetri lucidi e opachi in 7 raffinati colori.

The thin surface of the glass rests inside a Titanio finish aluminum frame, so the doors, when closed, create a smooth and elegant effect. The handle is integrated into the aluminum frame and reinvents the groove concept. A selection of polished and opaque glass in 7 stylish colours for the Aliant kitchen .

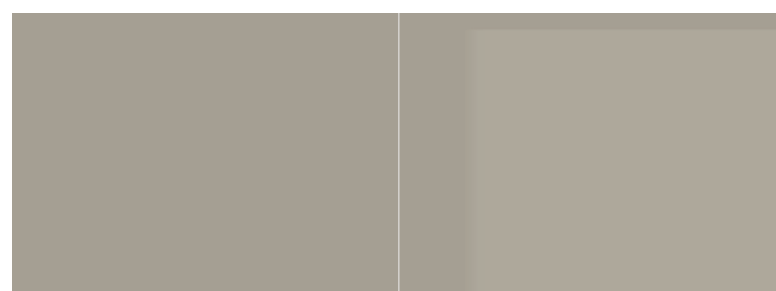

Piacenza opaco

Piacenza lucido

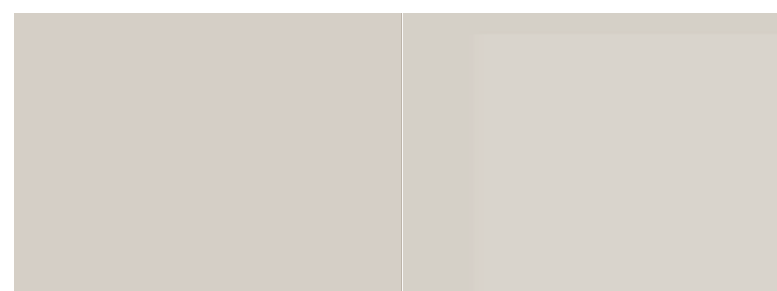

Pomice opaco

Pomice lucido

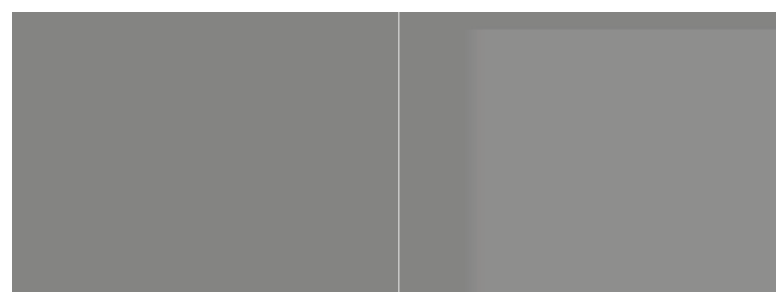

Lava opaco

Lava lucido

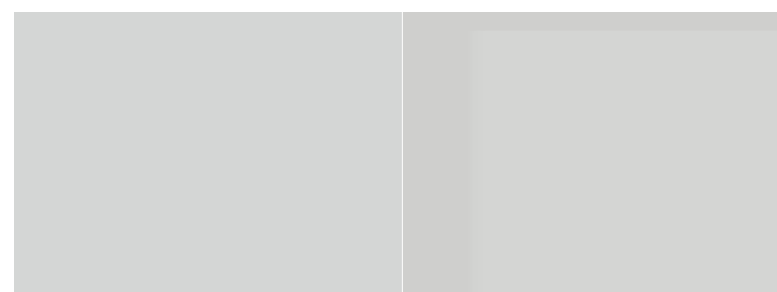

Frost

Frost lucido

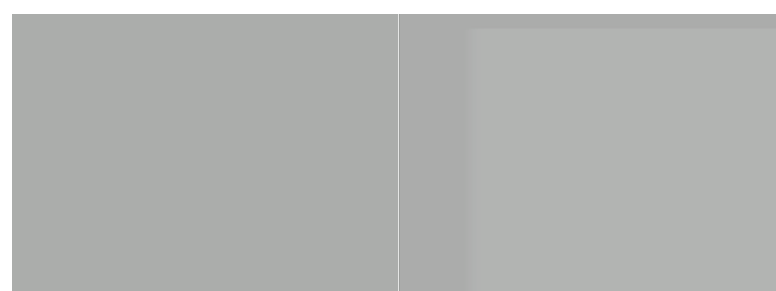

Grigio Daitona opaco

Grigio Daitona lucido

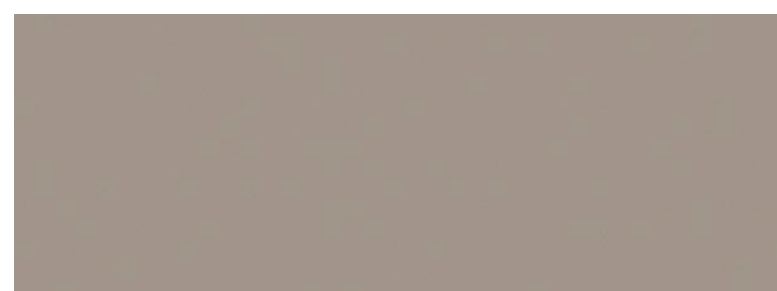

Bronzo

MANIGLIA A GOLA

GROOVE HANDLE

GOLA PIATTA CON TASCA disponibile in 5 colori.
FLAT GROOVE WITH POCKET available in 5 colors.



Brill

Bianco Opaco

Peltro

Piombo Opaco

Titanio



GOLA SCAVATA disponibile in 10 colori.
HOLLOW GROOVE available in 10 colors.



Acquamarina

Oliva

Rosso

Arancione

Bianco



Giallo

Corda

Piombo

Brill

Titanio



MAGGIOR SICUREZZA MAGGIOR STABILITÀ

MORE SAFETY MORE STABILITY



G*GRASS®

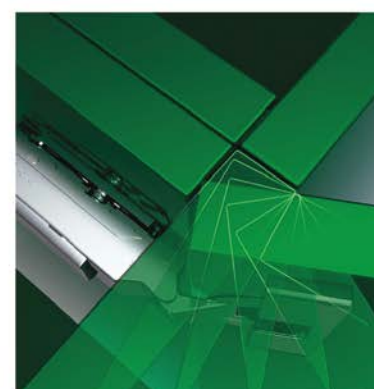
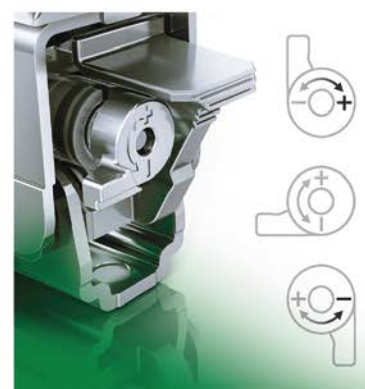

La tripla cerniera conferisce stabilità all'anta e maggior resistenza all'urto.

The triple hinge gives the door stability and greater resistance to slamming.

Stabilità costante in ogni posizione. Regolazione dell'altezza continua ed autobloccante.

Durable stability in every position. Stepless, self-locking height adjustment.

Con o senza frenata integrata. Stesso design per la combinazione di cerniere dotate e prive di Soft-close.

With or without integrated damping. Matching design for combinations of hinges with and without damping.

Maggiore comfort attraverso l'innovazione. Grazie al movimento della leva ottimizzato è possibile aprire le ante dei mobili in modo estremamente semplice.

Enhanced comfort thanks to new development. Optimised lever movement enables furniture doors to be opened with extreme ease.

Regolazione della frenata senza utensili. Chiusura uniforme indipendentemente dalle dimensioni e peso dell'anta.

Tool-free damper adjustment. Consistent closing action irrespective of door size and weight.

Design: Adriani e Rossi Edizioni
A. D. e Grafica: Adriani e Rossi Edizioni
Foto: Studio Indoor (Oderzo - TV)
Fotolito: Z13
Stampa: Eurotipo
Stampato in Italia Luglio 2015



Kitchen Design Since 1964



Stosa S.p.A.

STAB., SEDE AMM.VA E RECAPITO POSTALE:
S.S. Cassia, Km. 149,5
53040 Radicofani (SI) Italy

GPS:
N 42° 53' 50,6"
E 11° 45' 53,5"

INFO:
tel. +39 0578 5711 r.a.
fax +39 0578 50088

INFO LINE:
840 000 691

www.stosa.it stosa@stosa.it

