

/ DISEGNI TECNICI

technical drawings / Ausführungen
/ fiche technique / acabados / Технические чертежи

/ CODE

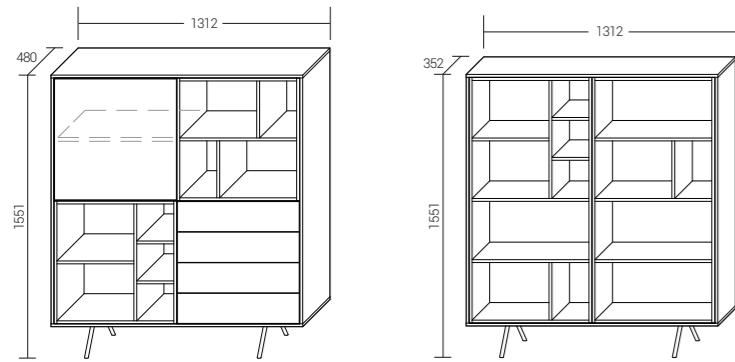
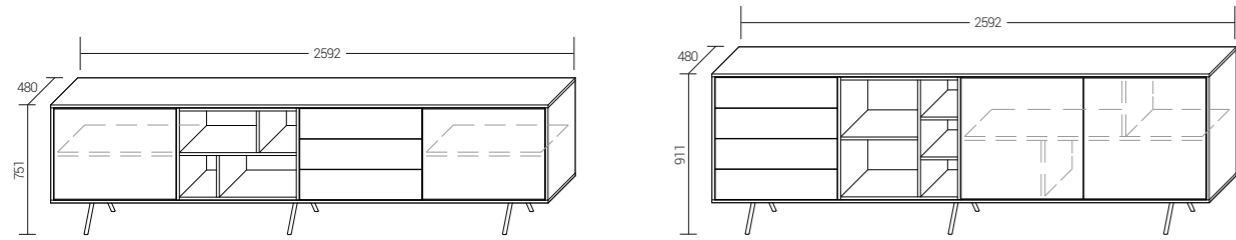
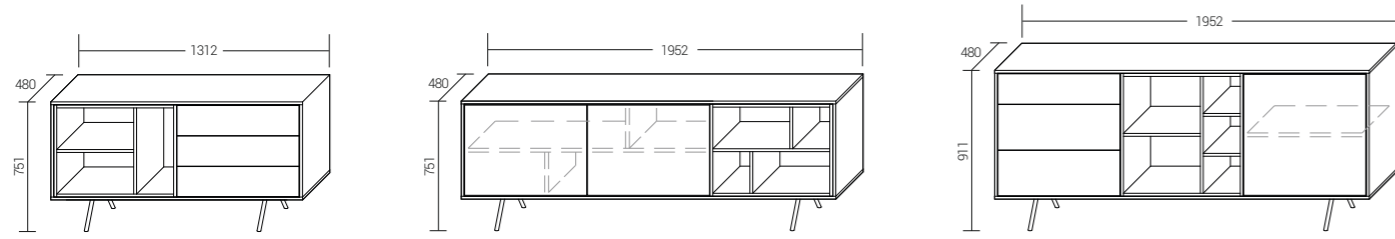

/ CONCRETE

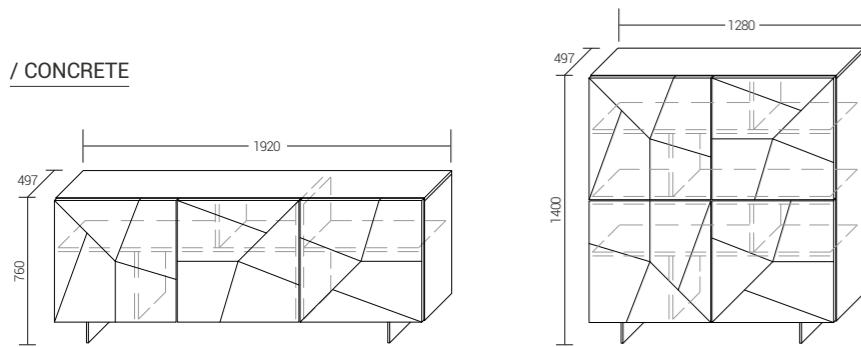

Misure riferite ai soli elementi fotografati. Per la gamma completa fare riferimento al listino. _Sizes referred only to the elements shown in the photos.
For the full range please refer to the price list. _ Die Masse beziehen sich auf die fotografierten Elemente. Die komplette Produktpalette ist auf der Preisliste ersichtlich. _Les mesures indiquées se réfèrent aux éléments photographiés. Pour la gamme complète, voir la liste de prix. _Las medidas se refieren a los elementos fotografiados. Para ver la disponibilidad completa consulte la tarifa. _Меры относятся только к сфотографированным элементам.
Для полного набора сослаться на прайс-лист.

/ SLASH

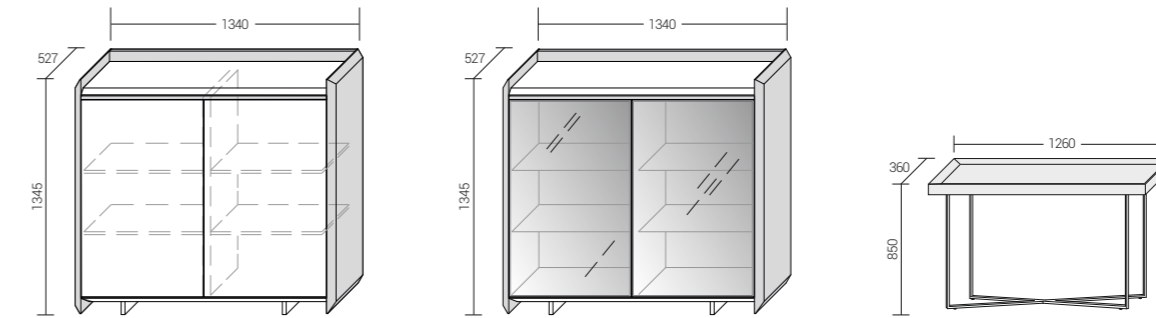
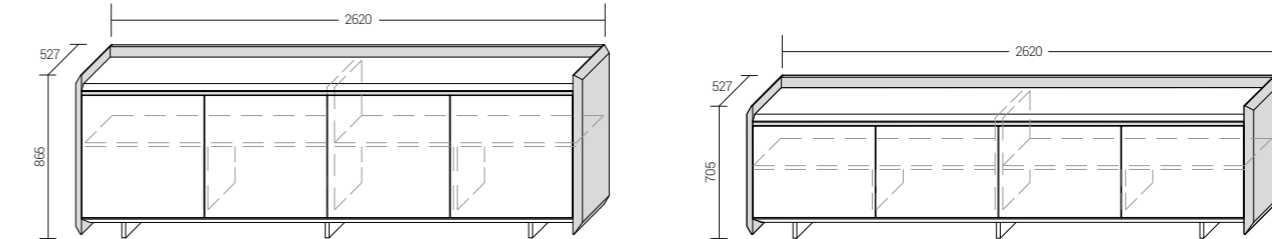

/ STRIPE

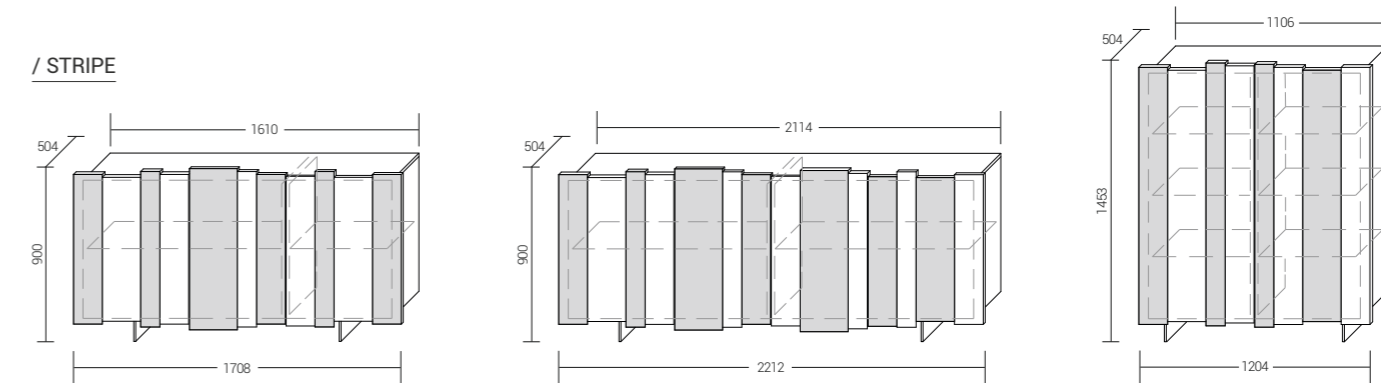

/ FRAME

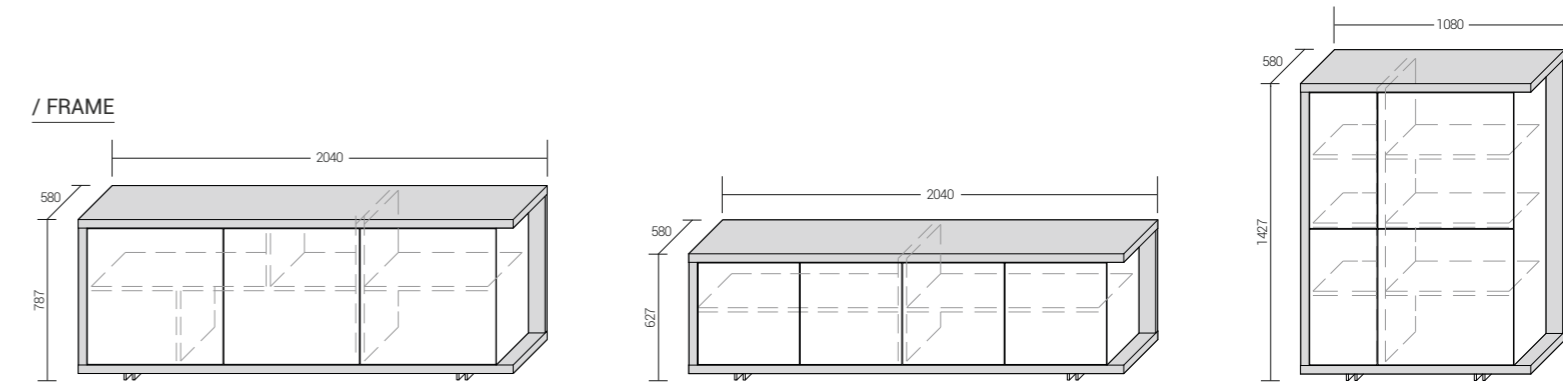

/ DISEGNI TECNICI

technical drawings / Ausführungen
/ fiche technique / acabados / Технические чертежи

/ SLIM

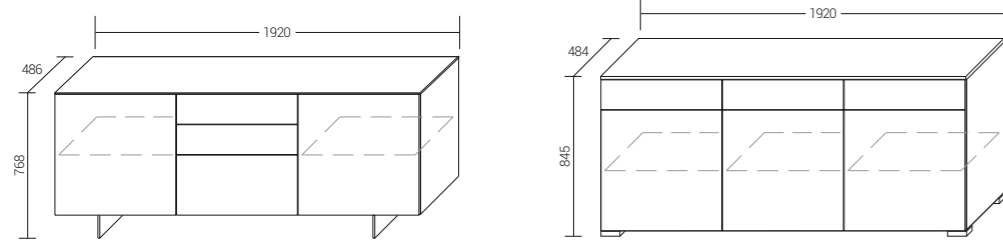

/ FIAMMA

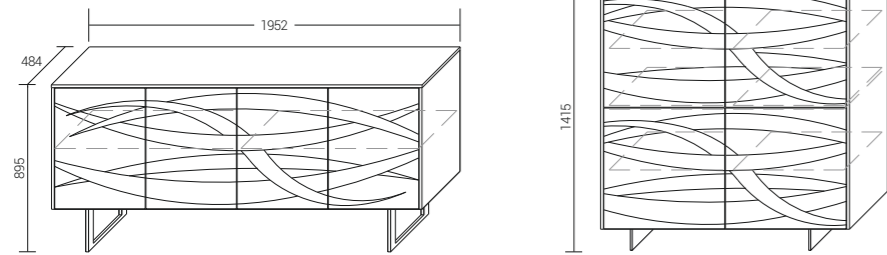

/ CUBE 4

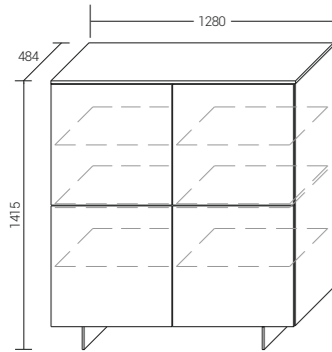

/ ZEN

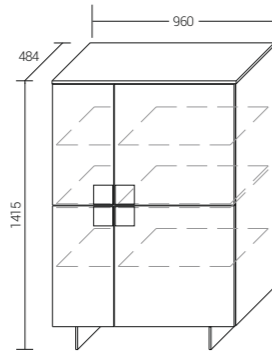

/ SLIDE

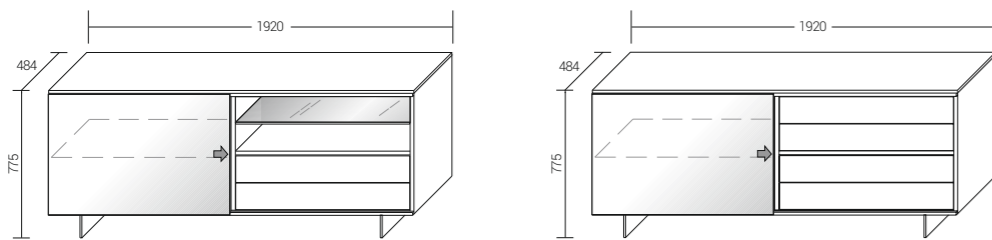

/ NIGHT

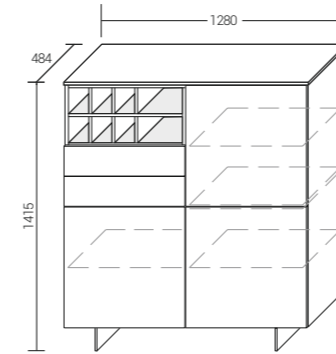

/ FASHION

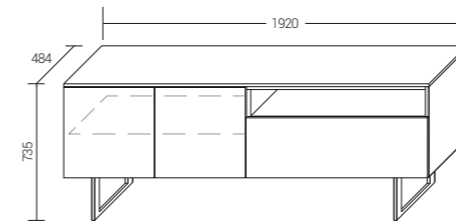

/ DESIGN

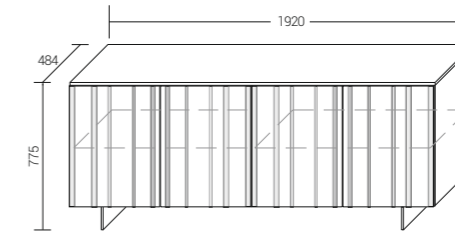

/ METAL

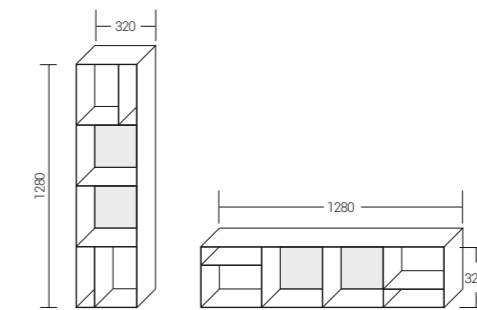

/ ONDA

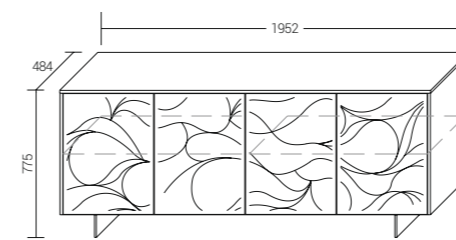

/ SCAFFALATURE PENSILI_WALL SHELVING SYSTEM

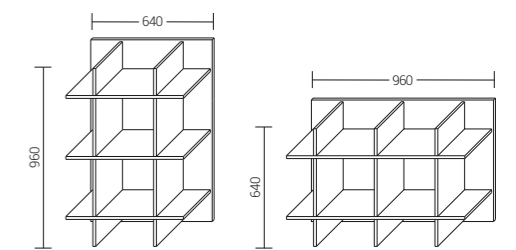

/ GLASS

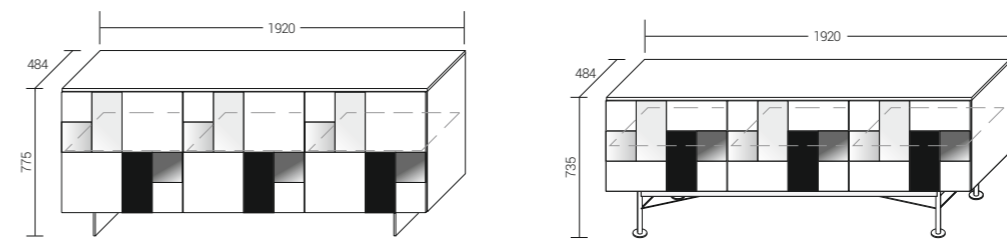

Misure riferite ai soli elementi fotografati. Per la gamma completa fare riferimento al listino. _Sizes referred only to the elements shown in the photos.
For the full range please refer to the price list. _ Die Masse beziehen sich auf die fotografierten Elemente. Die komplette Produktpalette ist auf der Preisliste ersichtlich. _Les mesures indiquées se réfèrent aux éléments photographiés. Pour la gamme complète, voir la liste de prix. _Las medidas se refieren a los elementos fotografiados. Para ver la disponibilidad completa consulte la tarifa. _Меры относятся только к сфотографированным элементам.
Для полного набора сослаться на прайс-лист.

/ DISEGNI TECNICI

technical drawings / Ausführungen
/ fiche technique / acabados / Технические чертежи

/ RUBINO

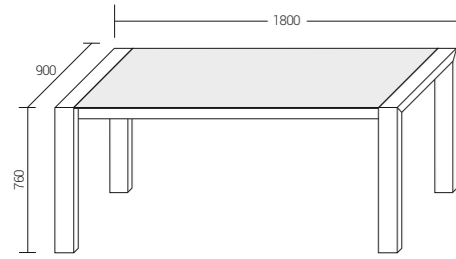

/ FLAP

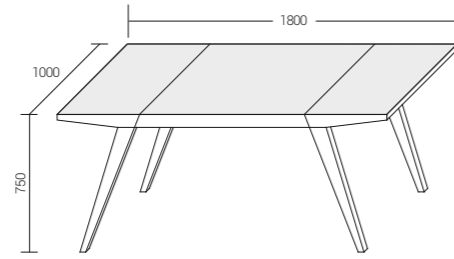

/ CROSS

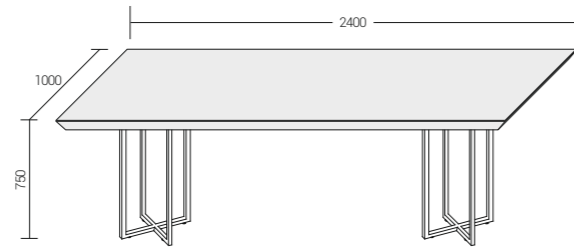
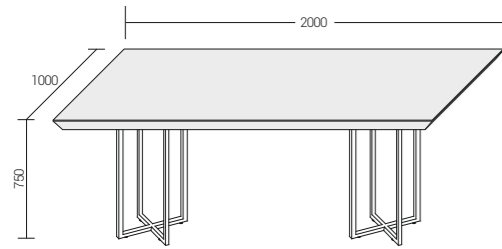

/ CROSS WOOD

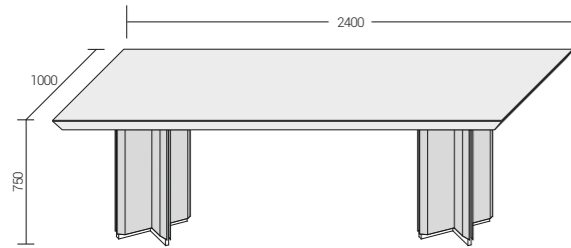

/ STRIPE

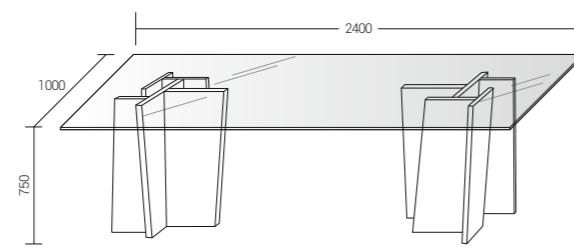

/ MAX

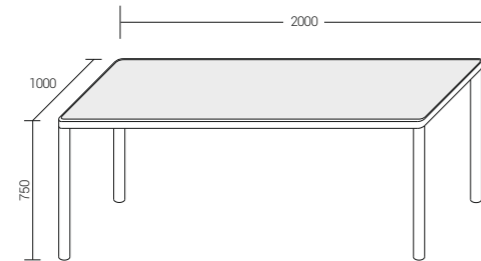
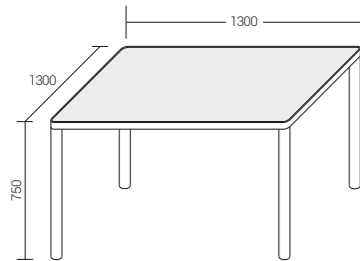

/ RADAR

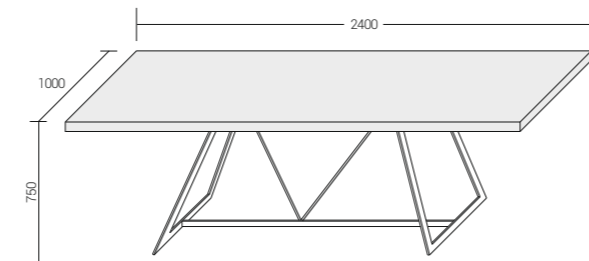

/ DIAMANTE

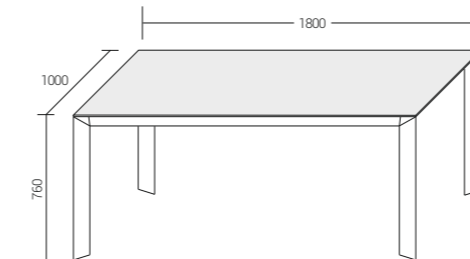

/ BASILIO

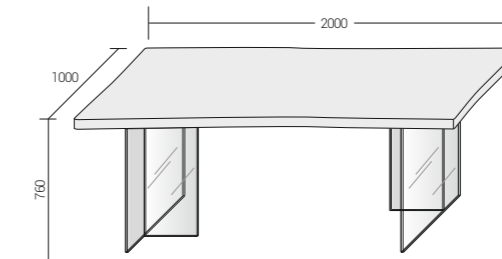

/ FLOWER

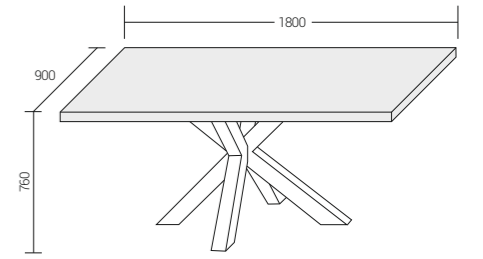

/ STRIPE

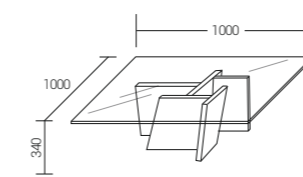

/ AMBO LITTLE

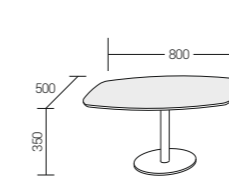

/ AMBO BIG

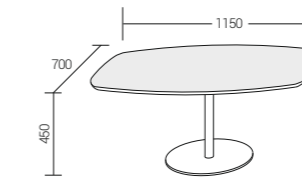

/ ZOE SMALL

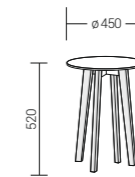

/ ZOE MEDIUM



/ ZOE LARGE

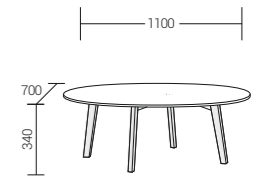

/ SLASH

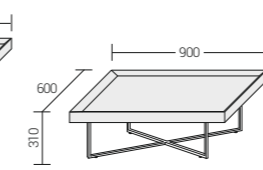
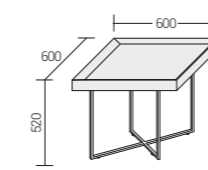

/ PITAGORA

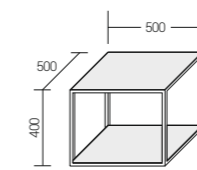

/ METAL

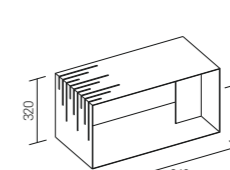

/ QUARZO

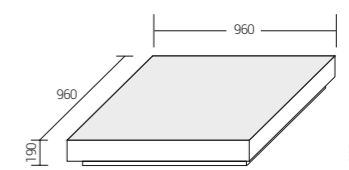

/ CRISTALLO

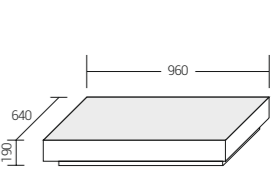

/ CALIGOLA

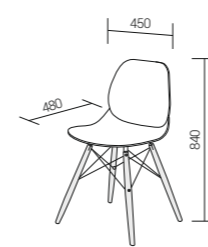

/ ADA

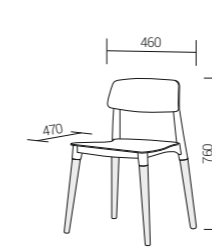

/ DEBBY



/ EMY

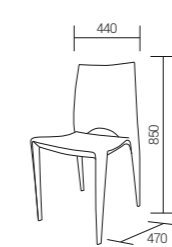

/ IOLE



/ IRIS

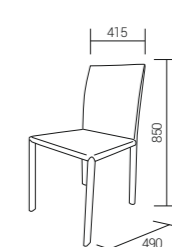

/ GHOST

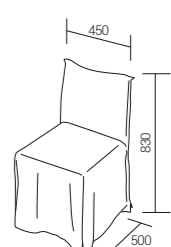

/ SARA

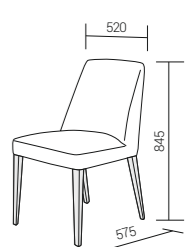

Misure riferite ai soli elementi fotografati. Per la gamma completa fare riferimento al listino. _Sizes referred only to the elements shown in the photos.
For the full range please refer to the price list. _ Die Masse beziehen sich auf die fotografierten Elemente. Die komplette Produktpalette ist auf der Preisliste ersichtlich. _Les mesures indiquées se réfèrent aux éléments photographiés. Pour la gamme complète, voir la liste de prix. _Las medidas se refieren a los elementos fotografiados. Para ver la disponibilidad completa consulte la tarifa. _Меры относятся только к сфотографированным элементам.
Для полного набора сослаться на прайс-лист.